

Professional Weather Center

model 02032C / 888143



CONTENTS

Unpacking Instructions	2	Backlight Settings	11
Package Contents	2	Placement Guidelines	12
Product Registration	2	5-in-1 Sensor Installation.....	13
Features & Benefits: 5-in-1	3	Using the Weather Center	14
Features: Display Unit	4	Rainfall Tracking	15
Back of Display Unit.....	6	Weather Ticker	16
Setup	7	Troubleshooting	17
5-in-1 Sensor Setup	7	Care & Maintenance.....	20
Display Unit Setup	8	Calibration	20
PC Connect Overview	9	Specifications.....	22
PC Connect Modes	9	FCC Information	22
PC Connect Software	10	Customer Support	23
Set the Time, Date & Units	11	Warranty.....	23

Questions? Contact Customer Support at (877) 221-1252 or visit www.AcuRite.com.

SAVE THIS MANUAL FOR FUTURE REFERENCE.

ACURITE®

Congratulations on your new AcuRite product. To ensure the best possible product performance, please read this manual in its entirety and retain it for future reference.

Unpacking Instructions

Remove the protective film that is applied to the LCD screen prior to using this product. Locate the tab and peel off to remove.

Package Contents

1. Display unit with tabletop stand
2. 5-in-1 sensor
3. Sensor mounting bracket
4. Mounting hardware
5. Snap-in debris filter for rain collector
6. Power adapter
7. USB cable
8. Instruction Manual
9. 4 Alkaline Batteries

IMPORTANT

PRODUCT MUST BE REGISTERED
TO RECEIVE WARRANTY SERVICE

PRODUCT REGISTRATION

Register online
to receive 1 year
warranty protection

www.AcuRite.com

REGISTER NOW

SUPPORT

Support Forum

Archived Products

▶ Register a Product

Features & Benefits

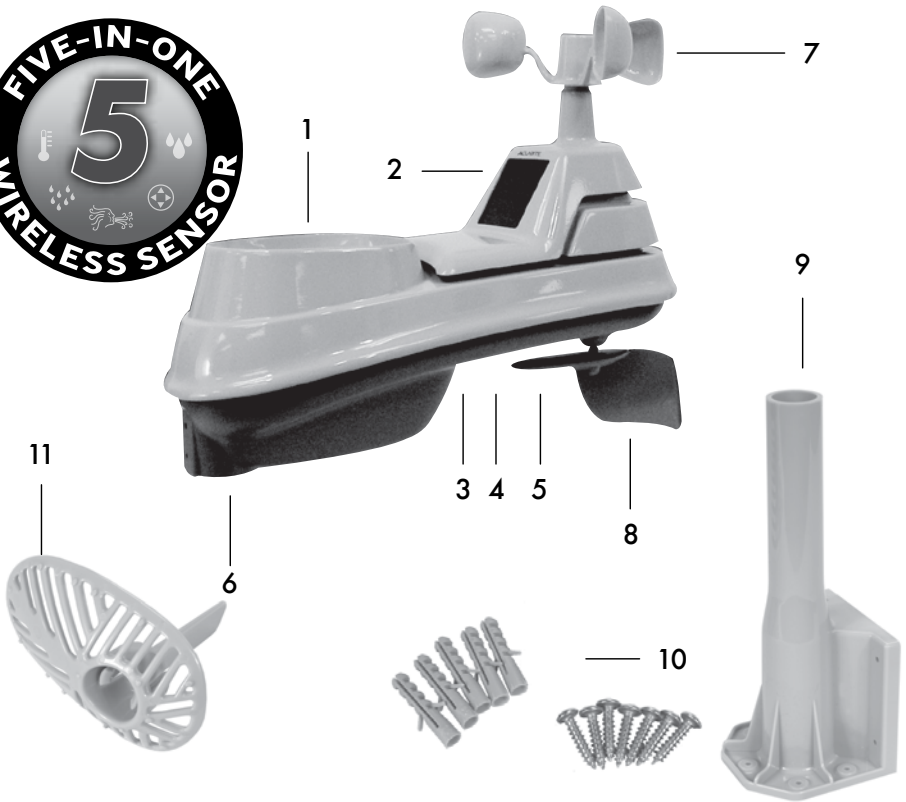

5-in-1 SENSOR

1. Rainfall Collector Funnel

2. Solar Cell Panel

Converts sunlight into power to run internal aspirating fan.

Internal Aspirating Fan (not shown)

Draws ambient air into sensor to reduce solar radiation heating, resulting in more accurate temperature measurement.

3. A-B-C Switch

ID code that must match display's A-B-C switch to ensure units synchronize.

4. Battery Compartment

5. Temperature & Humidity Sensors (internal)

6. Mounting Point

7. Wind Speed Anemometer

8. Wind Direction Vane

9. Mounting Bracket

10. Mounting Hardware

Includes anchors & screws.

Qty	Diameter	Length
5	#4	3/4"
1	#4	1/2"
1	#6	1/2"

11. Debris Filter

Snaps into rain collector to filter out twigs, leaves, etc.

Features & Benefits

Display Unit

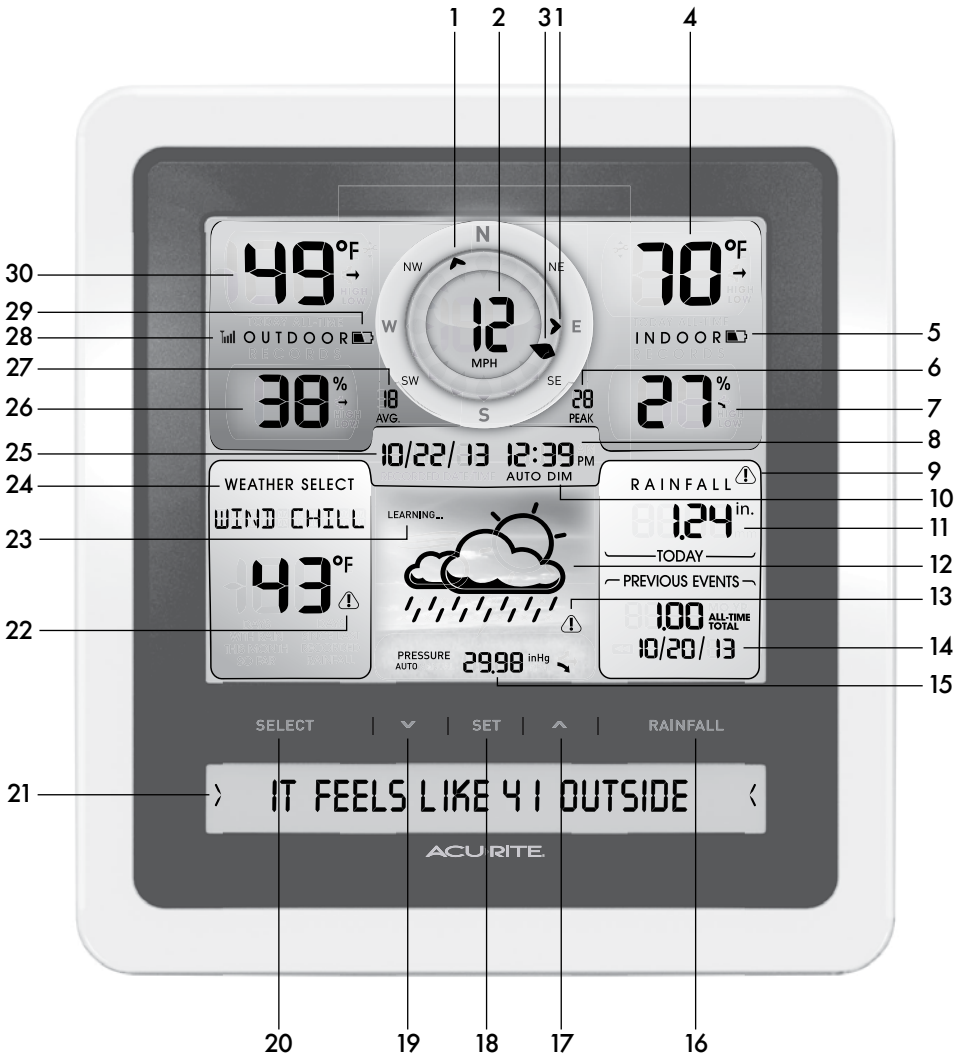

- 1. Previous 2 Wind Directions**
- 2. Current Wind Speed**
- 3. Current Wind Direction**
- 4. Current Indoor Temperature**
Arrow icon indicates direction temperature is trending.
- 5. Display Low Battery Indicator**
- 6. Peak Wind Speed**
Highest speed from the last 60 minutes.
- 7. Current Indoor Humidity**
Arrow icon indicates direction humidity is trending.
- 8. Clock**
- 9. Rainfall Alert Indicator**
Indicates rainfall of more than 1" of rain in 2 hours or less.
- 10. AUTO DIM Indicator**
- 11. Current Rainfall**
Accumulates data during rainfall.
- 12. 12 to 24 Hour Weather Forecast**
Self-Calibrating Forecasting pulls data from your 5-in-1 sensor to generate your personal forecast.
- 13. Storm Alert Indicator**
- 14. Month/Year/All-Time Rainfall**
- 15. Current Barometric Pressure**
Arrow icon indicates direction pressure is trending.
- 16. RAINFALL Button**
Press to change the RAINFALL data being displayed (Month, Year, All-Time).
- 17. ^ Button**
for setup preferences.
- 18. SET Button**
for setup preferences.
- 19. v Button**
for setup preferences.
- 20. SELECT Button**
Press to change the WEATHER SELECT category data being displayed.
- 21. Weather Ticker™**
- 22. Heat Index/ Wind Chill Alert Indicator**
- 23. Learning Mode Icon**
Disappears after weather forecast self-calibration is complete.
- 24. WEATHER SELECT**
Displays heat index, dew point, wind chill, feels like, days with rain this month, and days since last recorded rainfall.
- 25. Date**
- 26. Current Outdoor Humidity**
Arrow icon indicates direction humidity is trending.
- 27. Average Wind Speed**
of all speeds from past 2 minutes.
- 28. 5-in-1 Sensor Signal Strength**
- 29. Sensor Low Battery Indicator**
- 30. Current Outdoor Temperature**
Arrow icon indicates direction temperature is trending.

Back of Display Unit



BACK OF DISPLAY UNIT

- 1. Plug-in for Power Adapter**
- 2. Plug-in for USB Cable**
- 3. Integrated Hang Hole**
for easy wall mounting
- 4. MAC ADDRESS**
12 digit unique ID required for online connectivity functions
- 5. Backup Battery Compartment**
- 6. A-B-C Switch**
ID code that must match 5-in-1 sensor's A-B-C switch to ensure units synchronize

7. CLEAR RECORD/ RESET

Press to clear record currently being viewed. Press and HOLD for full reset to factory defaults.

8. Power Adapter

9. USB Cable for PC Connection

10. Battery Compartment Cover (not shown)

5-in-1 Sensor Setup

1 Set the A-B-C Switch

Locate the A-B-C switch inside the battery compartment. Set the A-B-C switch to A, B or C. You must select the same letter choices for both the sensor and the display unit in order for the units to synchronize.

2 Install or Replace Batteries

Batteries **MUST** be installed for this product to operate. AcuRite recommends high quality alkaline or lithium batteries for the best product performance. Heavy duty or rechargeable batteries are not recommended.

The 5-in-1 sensor requires lithium batteries in low temperature conditions. Cold temperatures can

cause alkaline batteries to function improperly. Use lithium batteries in the 5-in-1 sensor for temperatures below -4°F / -20°C.

1. Slide off the battery compartment cover.
2. Insert 4 x AA batteries into the battery compartment, as shown. Follow the polarity (+/-) diagram in the battery compartment.
3. Replace the battery cover.

3 Remove Rain Gauge Stabilizer

Locate and remove the rain gauge stabilizer (plastic tab) taped into the bottom of the sensor. The rain gauge will not function until this is removed.

LITHIUM BATTERIES **-40°F** (-40°C) (70°C) **158°F**

ALKALINE BATTERIES **-4°F** (-20°C) (70°C) **158°F**

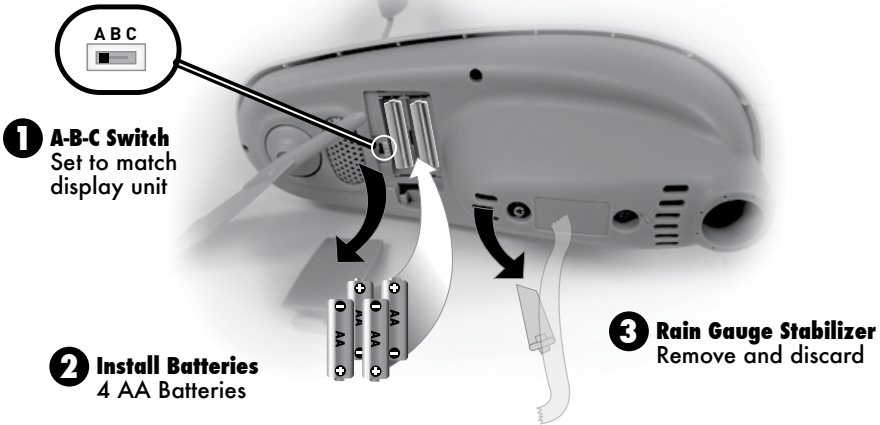

Display Unit Setup

1 Set the A-B-C Switch

The A-B-C switch is located inside the battery compartment. It can be set to A, B or C. However, you must select the same letter choices for both the sensor and the display unit in order for the units to synchronize.

2 Plug Power Adapter into Electric Outlet

1 A-B-C Switch set to match sensor

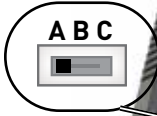

3 Write Down the MAC ADDRESS

12 digit unique ID needed for online connectivity functions.

24 C8 6E

4 Install or Replace Backup Batteries (optional)

Insert 3 x AA alkaline batteries into the battery compartment, as shown. Follow the polarity (+/-) diagram in the battery compartment.

3 Write Down MAC ADDRESS 12 digit number

4 Install Backup Batteries 3 AA Batteries

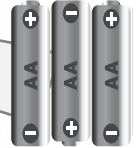

2 Plug in Power Adapter



IMPORTANT: Batteries are a backup power source to preserve records in the event of a power outage. Power adapter is the recommended primary power source to enjoy the full functionality of this product.



PLEASE DISPOSE OF OLD OR DEFECTIVE BATTERIES IN AN ENVIRONMENTALLY SAFE WAY AND IN ACCORDANCE WITH YOUR LOCAL LAWS AND REGULATIONS.

BATTERY SAFETY: Clean the battery contacts and also those of the device prior to battery installation. Remove batteries from equipment which is not to be used for an extended period of time. Follow the polarity (+/-) diagram in the battery compartment. Promptly remove dead batteries from the device. Dispose of used batteries properly. Only batteries of the same or equivalent type as recommended are to be used. DO NOT incinerate used batteries. DO NOT dispose of batteries in fire, as batteries may explode or leak. DO NOT mix old and new batteries or types of batteries (alkaline/standard). DO NOT use rechargeable batteries. DO NOT recharge non-rechargeable batteries. DO NOT short-circuit the supply terminals.

PC Connect Overview

PC Connect lets you access your Weather Center data in the following ways:

- **Data File:** Display unit logs (or stores) data so that you can download it to a PC in a data file (CSV, or comma-separated values file).
- **PC Weather Widget:** View data on your PC's screen as a widget.
- **Web Browser or Smartphone:** Monitor sensor data remotely using AcuRite's free AcuRite online software, or from a mobile device using the free AcuRite app, available from the iOS App Store or Google Play Store.

PC Connect USB Modes

To setup PC Connect, you must first select a USB mode on the display unit.

Note: The PC Connect software **MUST** be installed on your computer **BEFORE** connecting the display unit to the computer.

Mode 1: Display Logging ON

- Display unit logs (stores) up to 2 weeks of data in memory. When memory nears capacity, display unit's Weather Ticker displays an alert to download memory soon.
- Transfer data to your PC using PC Connect.

Mode 2: Display Logging OFF (DEFAULT)

- Display unit **DOES NOT** log (save) any data in memory for PC transfer.

Mode 3: Display Logging ON/Internet Bridge Mode

- Display unit logs (stores) up to 2 weeks of data in memory.
- Transfer data to your PC using PC Connect.
- Stream your data from your weather center to online sources.*

Mode 4: Display Logging OFF/Internet Bridge Mode

- Display unit **DOES NOT** log (save) any data in memory.
- Stream your data from your weather center to online sources.*

* PC and internet connection must remain ON to continuously stream data from your weather center to online sources or the AcuRite mobile app.

USB Mode	DISPLAY UNIT...		
	Shows Data	Stores Data	Streams Online*
1	✓	✓	
2	✓		
3	✓	✓	✓
4	✓		✓

Download the PC Connect Software

The PC Connect software is available online as a free download. An instruction manual for PC Connect is included (PDF file) when you download the software. Read the manual to learn how to setup PC Connect preferences and features.

- 1 Download PC Connect software to your computer by visiting:
<http://www.acurite.com/pc-connect-download>

Or, you can navigate to the page above using the following path:
www.acurite.com > Support > Manuals & Downloads > Downloads > PC Connect

- 2 Click the "setupacu-link" file you downloaded and follow the on-screen instructions to install the PC Connect software. A folder named "AcuRite" will be installed on your computer.

- 3 After PC Connect is installed on your computer, open the PC Connect app. Verify that the display unit is powered on with the AC power adapter plugged in, then connect the small end of the USB cable into the USB port located inside the battery compartment on the back of the display unit.

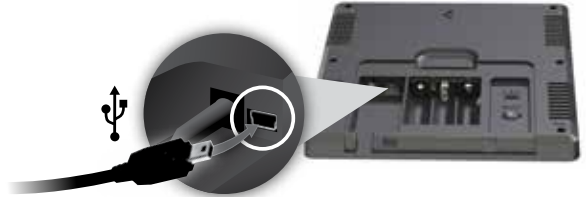

- 4 Connect the larger end of the USB cable into a USB port on your computer.



- 5 USB functions on the display unit are OFF by default. Verify the display unit is powered on and receiving data from the outdoor sensor. Next, set the mode on the display unit. Set to mode 3 for full PC Connect functionality, or see page 9 for a description of all available modes.

- 6 Select the SAME USB mode in the PC Connect software that you chose on your display unit.

PC Connect is now ready for use. Please note that it may take up to 1 minute for the PC Connect software to begin receiving data from the display unit.

Set the Time, Date & Units

Press the "SET" button, located on the front of the display unit, to enter SET MODE. Once in set mode, the preference you are currently setting will blink on the display.

To adjust the currently selected (flashing) item, press and release the "∧" or "∨" buttons (press and HOLD to fast adjust).

To save your adjustments, press and release the "SET" button again to adjust the next preference. The preference set order is as follows:

TOP DISPLAY:

CLOCK HOUR

CLOCK MINUTE

CALENDAR MONTH

CALENDAR DATE

CALENDAR YEAR

TEMPERATURE UNITS (°F or °C)

WIND SPEED UNITS (MPH, KPH, Knots)

RAINFALL UNITS (in or mm)

PRESSURE UNITS (inHg or hPa)

TICKER DISPLAY:

LANGUAGE (English, French, Spanish)

WEATHER TICKER SPEED (SLOW, MEDIUM, FAST)

PC CONNECT MODE (1, 2, 3, 4)

You will automatically exit SET MODE if no buttons are pressed for 20 seconds. Enter setup mode at any time by pressing the "SET" button.

Display Backlight Settings

This weather station's color display features three different lighting settings: High (100%) brightness, Medium (60%) brightness and Low (30%) brightness

Using battery power alone, the backlight is available momentarily for 10 seconds by pressing the "BACKLIGHT" button.

When display is powered with the power adapter, backlight remains on at 100% brightness. Press "BACKLIGHT" button once to dim to 60% brightness; press again to dim to 30%, press a 3rd time to enter "AUTO DIM" mode. "AUTO DIM" will appear below the time.

AUTO DIM MODE: Automatically adjusts display brightness based on time of day & year.	
MARCH 11- NOVEMBER 4	6:00 a.m. - 9:00 p.m. = 100% brightness
	9:01 p.m. - 5:59 a.m.= 30% brightness
NOVEMBER 5 - MARCH 10	7:30 a.m. - 7:00 p.m.= 100% brightness
	7:01 p.m. - 7:29 a.m. = 30% brightness

Placement for Maximum Accuracy

AcuRite sensors are sensitive to surrounding environmental conditions. Proper placement of both the display unit and the sensor are critical to the accuracy and performance of this product.



Display Unit Placement

Place the display unit in a dry area free of dirt and dust. To ensure accurate temperature measurement, place out of direct sunlight and away from heat sources or vents. Display unit stands upright for tabletop use or is wall-mountable.



5-in-1 Sensor Placement

The 5-in-1 sensor is designed to remain outdoors all year long. Choose an open location with no obstructions above or around the sensor for the most accurate measurements.

Important Placement Guidelines

Display unit and sensor must be within 330 feet (100 m) of each other.

MAXIMIZE WIRELESS RANGE

Place units away from large metallic items, thick walls, metal surfaces, or other objects that may limit wireless communication.

PREVENT WIRELESS INTERFERENCE

Place both units at least 3 feet (.9 m) away from electronic devices (TV, computer, microwave, radio, etc.).

LOCATE AWAY FROM HEAT SOURCES

Position sensor away from heaters, air conditioners, chimneys, exhaust vents, asphalt and concrete (surfaces that radiate heat).

LOCATE AWAY FROM HUMIDITY SOURCES

Avoid installing the sensor near pools, spas, or other bodies of water. Water sources may impact humidity accuracy.

LOCATE AWAY FROM SPRINKLER HEADS

DO NOT install the sensor where it will be sprayed by a sprinkler system. This may force water inside the sensor.

LOCATE AWAY FROM WIND & RAIN OBSTRUCTIONS

DO NOT mount the sensor with obstructions around it. Consider a location that is a wide open area, with few structures around to ensure accurate wind measurement.

Visit us online to view installation photos and video, or learn more about AcuRite technology:

www.AcuRite.com/5in1



View Video

5-in-1 Sensor Installation Guidelines

INSTALLATION HEIGHT Mount the sensor at a minimum height of 5 feet (1.5 meters) off the ground, in an open area. Higher is better for wind measurements- the National Weather Service recommends 33 feet (10 meters) high!

MOUNTING OPTIONS The included mounting bracket is designed to screw directly onto wooden posts or surfaces that are 2"x4" or larger. The sensor can also be mounted directly to 3/4" steel or PVC pipe (available at hardware stores and home centers).

SOLAR CELL INSTALLATION Install the sensor with the **solar cell facing SOUTH**. This ensures the cell receives as much sun as possible and orients wind direction.

5-in-1 Sensor Installation

1. Fasten mounting base (included) to a post or pole (not included) using the 4 longer screws included in the hardware bag.
2. Insert the mounting base into the hole on the bottom of the sensor.
3. Make sure the arrows on the top of the sensor are pointed in the proper direction and the bubble level is centered. The solar cell should be facing south to properly orient the wind direction.
4. Fasten the sensor into the mounting base using the 2 shorter screws included in the hardware bag.

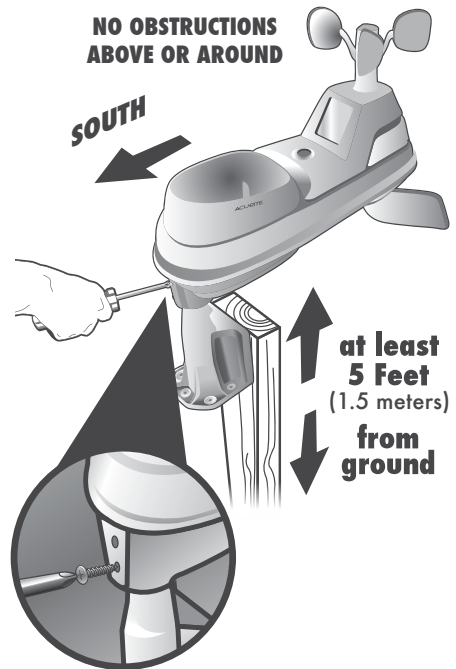

The 5-in-1 sensor is now ready to use.

Clear Data Collected During Installation

When installation is complete, clear erroneous data from the display unit by pressing the "CLEAR RECORD/ RESET" button, on the back of the display inside the battery compartment. This button will clear data recorded since 12:00 am.

Basic Setup is Complete

The 5-in-1 sensor will now synchronize with the display unit. It may take a few minutes for synchronization to complete. If both or one of the units appear to be functioning improperly, please refer to the troubleshooting section.





Using the Professional Weather Center

Learning Mode

Self-Calibrating Forecasting use a unique algorithm to analyze changes in pressure over a time period (called Learning Mode) to determine your altitude. After 14 days, the Learning Mode icon disappears from the display screen. At this point, the self-calibrated pressure is tuned in to your location and the unit is ready for superior weather prediction.

Weather Forecast

AcuRite's patented Self-Calibrating Forecasting provides your personal forecast of weather conditions for the next 12 to 24 hours by collecting data from the sensor in your backyard. It generates a forecast with pinpoint accuracy - personalized for your exact location.

<p>STORMY & WINDY</p>  <p>(flashing=stormy)</p>	<p>SNOW LIKELY</p> 	<p>SNOW / RAIN MIX LIKELY</p>  <p>(flashing rain/snow)</p>	<p>RAIN LIKELY</p> 	<p>MOSTLY CLOUDY</p> 
--	---	--	---	---

View the complete list of icons at www.AcuRite.com/acurite-icons

Weather Select

Weather Select displays data including wind chill, dew point, heat index, feels like, days with rain this month, and days since last recorded rainfall. To change the "Weather Select" category shown, press the "SELECT" button on the front of the display. To clear a record, view one of the values listed above and press the "CLEAR RECORD/RESET" button, located on the back of the unit in the battery compartment. Dashes display to confirm the record has been cleared.

Barometric Pressure

Subtle variations in barometric pressure greatly affect the weather. This weather center displays the current pressure with an arrow icon to indicate the direction the pressure is trending (FALLING, STEADY, or RISING).

Rainfall Tracking

This weather station features enhanced tracking of historical rainfall data. Rain accumulation data is recorded for today, over all-time, by year, by month, and by rainfall event.

Press the "RAINFALL" button to review rainfall records. The  icon is shown on the display while historical data is being viewed.

Records are shown in the following order:

- PREVIOUS RAINFALL #1 *
- PREVIOUS RAINFALL #2 *
- PREVIOUS RAINFALL #3 *
- CURRENT MONTH TOTAL RAINFALL
- PREVIOUS MONTH TOTAL RAINFALL
- 2 MONTHS AGO TOTAL RAINFALL
- CURRENT YEAR TOTAL RAINFALL
- PREVIOUS YEAR TOTAL RAINFALL
- ALL-TIME TOTAL RAINFALL (date shown is start date of the all-time total; the date the display was powered on)



TOTAL RAINFALL
FOR DATE SHOWN

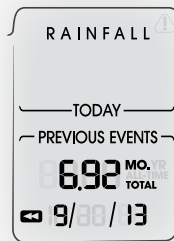

TOTAL RAINFALL
FOR MONTH SHOWN

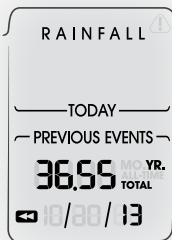

CURRENT YEAR
TOTAL RAINFALL



PREVIOUS YEAR
TOTAL RAINFALL

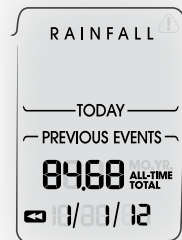

ALL-TIME
TOTAL RAINFALL

* Previous rainfall is the amount of rain recorded from 12:00am to 11:59pm on the date shown.

Weather Ticker™

The Weather Ticker automatically flashes your real-time weather information and alerts as text in the lower part of the display unit screen.

The possible WEATHER TICKER messages are as follows:

HEAT INDEX-XX
WINDCHILL-XX
DEW POINT-XX
IT FEELS LIKE XX OUTSIDE
7 DAY HIGH TEMP. XX- MM/DD
7 DAY LOW TEMP. XX- MM/DD
30 DAY HIGH TEMP. XX- MM/DD
30 DAY LOW TEMP. XX- MM/DD
ALL TIME HIGH TEMP. XXX...RECORDED MM/DD/YY
ALL TIME LOW TEMP. XXX...RECORDED MM/DD/YY
24 HOUR TEMP. CHANGE +XX
ALL TIME HIGH WIND XX MPH...RECORDED MM/DD/YY
7 DAY AVERAGE WIND XX MPH
TODAY'S AVERAGE WIND XX MPH
MOON- NEW
MOON- WAXING CRESCENT
MOON- FIRST QUARTER
MOON- WAXING GIBBOUS
MOON- FULL
MOON- WANING GIBBOUS
MOON- LAST QUARTER
MOON- WANING CRESCENT
INDOOR HUMIDITY OK
INDOOR HUMIDITY HIGH
INDOOR HUMIDITY LOW
NEW LOW TEMP. RECORD XX
NEW HIGH TEMP. RECORD XX
NEW WIND RECORD TODAY XX
CURRENT RAINFALL X.XX/HR.
RAIN EVENT STARTED XX HRS. AGO
SENSOR BATTERIES LOW
DISPLAY BATTERIES LOW
SENSOR SIGNAL LOST...CHECK BATTERIES AND PLACEMENT
CAUTION- HEAT INDEX IS XXX
CAUTION- WIND CHILL IS XXX
CALIBRATION
DATA LOGGER FULL...CONNECT TO PC TO TRANSFER

Troubleshooting

Problem	Possible Solution
<p>No outdoor sensor reception</p>  no bars	<ul style="list-style-type: none"> • Relocate the display unit and/or the 5-in-1 sensor. The units must be within 330 ft (100 m) of each other. • Make sure both units are placed at least 3 feet (.9 m) away from electronics that may interfere with the wireless communication (such as TVs, microwaves, computers, etc). • Use standard alkaline batteries (or lithium batteries in sensor when temperature is below -4°F/-20°C). Do not use heavy duty or rechargeable batteries. NOTE: It may take up to 20 minutes for display unit and sensor to synchronize after batteries are replaced. • Synchronize the units: <ol style="list-style-type: none"> 1. Bring both the sensor and display unit indoors and remove power adapter/batteries from each. 2. Reinstall batteries in outdoor sensor. 3. Reinstall power adapter/batteries in display unit. 4. Let the units sit within a couple feet of each other for about 20 minutes to gain a strong connection.
<p>Outdoor temperature is flashing or showing dashes</p>	<p>Flashing of the outdoor temperature may be an indication of wireless interference.</p> <ul style="list-style-type: none"> • Make sure the A-B-C switch in the battery compartments of both the display unit and sensor are switched to the same letter. You may choose A, B or C; but both units must match to sync up. Sometimes changing to a different channel can help.
<p>Weather Ticker Hard to Read</p>	<ul style="list-style-type: none"> • Slow down the speed of the ticker (see page 11).
<p>Inaccurate forecast</p>	<ul style="list-style-type: none"> • Weather Forecast icon predicts conditions for the next 12 to 24 hours, not current conditions. • Has Learning Mode icon disappeared from the display unit? Learning Mode must complete before forecast and pressure will be accurate. • Allow unit to run continuously for 33 days. Battery removal or resetting the display unit will restart Learning Mode. After 14 days, forecast should be fairly accurate, however Learning Mode calibrates for a total of 33 days.

Troubleshooting

Problem	Possible Solution
Inaccurate temperature or humidity	<ul style="list-style-type: none">• Make sure both the display unit and 5-in-1 sensor are placed away from any heat sources or vents (see page 12).• Make sure both units are positioned away from moisture sources (see page 12).• Make sure 5-in-1 sensor is mounted at least 5 ft off of the ground.• Calibrate indoor and outdoor temperature and humidity (see page 20).
No rainfall	<ul style="list-style-type: none">• Check to ensure the rain gauge stabilizer (plastic tab) has been removed from the bottom of the sensor (see page 7).• Clear debris, such as leaves, out of the rain collector funnel and debris screen.• Calibrate the Rain Gauge (see page 21).
Inaccurate wind readings	<ul style="list-style-type: none">• What is wind reading being compared to? Pro weather stations are typically mounted at 30 ft high or more. Make sure to compare data using a sensor positioned at the same mounting height.• Check location of the sensor. Ensure it's mounted a minimum of 5 ft in the air with no obstructions around it (within several feet).• Ensure wind cups are spinning freely. If they hesitate or stop try lubricating with graphite powder or spray lubricant.
Display screen not working	<ul style="list-style-type: none">• Check that the batteries are installed correctly. Batteries may need to be replaced.• Reset the display by pressing and holding the CLEAR RECORD / RESET button, located in the battery compartment of the display unit. Date and time will need to be entered after a reset.

Troubleshooting

Problem	Possible Solution
Cannot access data online or on the AcuRite mobile app	<ul style="list-style-type: none">• Confirm the status readout in PC Connect software on your PC indicates that data was uploaded OK.• Make certain you created an account or logged into your existing account on www.acu-link.com, and that you have setup your display unit MAC ADDRESS online, as well.• Check that the USB cable is securely connected to the display unit AND to your PC USB port.• Make certain the display unit is powered on.• Make certain the PC your display unit is connected to is always powered on.• Make certain the PC your display unit is connected to is always connected to the internet.• Confirm the display unit USB mode is 3 or 4.• Confirm your display unit MAC ADDRESS is entered into the "UPLOAD" window correctly in the PC Connect Software on your PC.• Confirm that the "ENABLE" box is checked in the "UPLOAD" window in the PC Connect Software on your PC.• Confirm your display unit's MAC ADDRESS is correct in your account at www.acu-link.com and on the AcuRite mobile app.• Restart the PC Connect Software.• Restart your PC.
PC Connect software data is different than display unit data	<ul style="list-style-type: none">• Check that the USB cable is securely connected to the display unit AND to your PC USB port.• Confirm that the correct USB mode is selected on your display unit.• Restart the PC Connect Software.• Unplug the USB cable from your PC for about 1 minute, re-insert.• USB port may be malfunctioning, try another USB port.

If your AcuRite product does not operate properly after trying the troubleshooting steps, visit www.AcuRite.com or call (877) 221-1252 for assistance.

Care & Maintenance

Display Unit Care

Clean with a soft, damp cloth. Do not use caustic cleaners or abrasives. Keep away from dust, dirt and moisture. Clean ventilation ports regularly with a gentle puff of air.

5-in-1 Sensor Care

Clean the Sensor

Clean with a soft damp cloth. Do not use caustic cleaners or abrasives that will mar the polished surfaces of the rain collection funnel or the solar cell. Scratches will result in decreased performance and reliability.

Insect Prevention

Insects may cause obstructions and interrupt data by nesting in or on the 5-in-1 sensor. To limit this problem, spray sensor with a household insect repellent. Consult the insect repellent instructions prior to use.

Snow & Freezing Weather

The 5-in-1 sensor will not be damaged by freezing conditions. NOTE: If the rain collector cup fills with snow and then melts, it will register as rain on the display unit.

Clean the Rain Collector Cup

Remove and empty rain collector debris filter. The debris filter is located in the rain collector funnel. Remove from the top by gently squeezing and pulling out.

Clean the Wind Vane & Anemometer

Remove foreign matter from the outside of the sensor for free movement of the wind vane and anemometer. If needed, use a small amount of spray lubricant, clear silicone or graphite powder on the anemometer for improved movement.

Calibration

The indoor / outdoor temperature and humidity readings, and barometric pressure can be calibrated on the display unit to improve accuracy. Calibration can improve accuracy when sensor placement or environmental factors impact the data accuracy.

1. To access calibration mode, press AND HOLD the “^”, “SET”, and “v” buttons simultaneously for at least 5 seconds.
2. To adjust the currently selected (flashing) item, press and release the “^” or “v” buttons to calibrate the data value higher or lower from the actual reading.
3. To save your adjustments, press and release the “SET” button to adjust the next preference. The “☀” icon will remain illuminated next to calibrated values.

The preference set order is as follows:

OUTDOOR TEMPERATURE

OUTDOOR HUMIDITY

INDOOR TEMPERATURE

INDOOR HUMIDITY

BAROMETRIC PRESSURE (must be set to MANUAL mode to calibrate)*

*To change from AUTO to MANUAL pressure mode and vice versa, press AND HOLD the "SET" button for at least 10 seconds. The display indicates the current pressure mode selected, "AUTO" or "MANUAL".

After 20 seconds of inactivity, the display will save the adjustments and exit calibration mode. Note: Calibrations will be erased if the display is reset or if batteries are removed and the power adapter is unplugged.

Calibrate the Rain Gauge

The rain gauge on the 5-in-1 sensor can be calibrated to improve accuracy.

Items Needed: 5-in-1 sensor, display unit, plastic cup, pin, screw driver

1. First, ensure 5-in-1 sensor is perfectly level using built-in bubble level.
2. Place display unit close so you can monitor it during calibration.
3. Make a pin hole in the bottom of a plastic cup. Hold the cup over the rain gauge and fill it with exactly 1 cup (8oz) of water, allowing the water to drip into the rain gauge. You should hear the internal buckets tip and see water drain through the rain gauge.
4. A few seconds after each bucket tip, the display unit displays rainfall in approximately 0.01" or more increments.
5. The cup of water should take more than 20 minutes to empty; a quicker period will result in inaccurate calibration. Try to simulate a normal steady rainfall. When cup is empty of water, display unit should register 1.06"

Tips

- There should be nearly an equal number of water drops (about 25 water drops) between bucket tips. If not, adjust the calibration screws on the bottom of the 5-in-1 sensor until an equal number of water drops are tipping the buckets. Then, restart the calibration procedure.
- If you don't hear the buckets tipping and see water dripping alternately out of each drain, there may be an issue with the rain gauge or it's adjustment. See Troubleshooting on page 18.

Adjustment

If the rain gauge doesn't register close to 1.06", make an EQUAL adjustment to the two calibration screws on the bottom of the 5-in-1 sensor. Turning screws clockwise increases rainfall; counter clockwise decreases rainfall.

- To adjust the rainfall reading by 2% turn both screws 1/8 of a turn.
- To adjust the rainfall reading by 4% turn both screws 1/4 of a turn.
- To adjust the rainfall reading by 8% turn both screws 1/2 of a turn.

Watch the video at www.acurite.com/5n1

Specifications

TEMPERATURE RANGE	Outdoor: -40°F to 158°F; -40°C to 70°C
	Indoor: 32°F to 122°F; 0°C to 50°C
HUMIDITY RANGE	Outdoor: 1% to 99%
	Indoor: 1% to 99%
WIND SPEED	0 to 99 mph; 0 to 159 kph
WIND DIRECTION INDICATORS	16 points
RAINFALL	0 to 393 in; 0 to 9999mm
WIRELESS RANGE	330ft / 100m depending on home construction materials
OPERATING FREQUENCY	433 MHz
POWER	Display: 4.5V, 250mA AC adapter 3 x AA alkaline batteries (optional)
	Sensor: 4 x AA alkaline or lithium batteries
DATA REPORTING	Wind Speed: 18 second updates; Direction: 30 seconds Outdoor temperature & humidity: 36 second updates Indoor temperature & humidity: 60 second updates PC Connect CSV Data Logging: 12 minute intervals PC Connect to AcuRite Software/App: 18 seconds
DISPLAY UNIT MEMORY	512 kilobytes (not expandable)
PC CONNECT SYSTEM REQUIREMENTS	Windows® XP / Vista / 7 / 8 and available USB port
	High speed internet is required to use some advanced features of PC Connect, such as the AcuRite software and app.

FCC Information

This device complies with part 15 of FCC rules. Operation is subject to the following two conditions:

- 1- This device may NOT cause harmful interference, and
- 2- This device must accept any interference received, including interference that may cause undesired operation.

This equipment has been tested and found to comply with the limits for a Class B digital device, pursuant to Part 15 of the FCC rules. These limits are designed to provide reasonable protection against harmful interference in a residential installation. This equipment generates, uses and can radiate radio frequency energy and, if not installed and used in accordance with the instructions, may cause harmful interference to radio communications. However, there is no guarantee that interference will not occur in a particular installation. If this equipment does cause harmful interference to radio or television reception, which can be determined by turning the equipment off and on, the user is encouraged to try to correct the interference by one or more of the following measures:

- Reorient or relocate the receiving antenna.
- Increase the separation between the equipment and the receiver.
- Connect the equipment into an outlet on a circuit different from that to which the receiver is connected.
- Consult the dealer or an experienced radio/TV technician for help.

NOTE: The manufacturer is not responsible for any radio or TV interference caused by unauthorized modifications to this equipment. Such modifications could void the user authority to operate the equipment.

This device complies with Industry Canada licence-exempt RSS standard(s).

Operation is subject to the following two conditions:

- (1) This device may not cause interference, and
- (2) This device must accept any interference received, including interference that may cause undesired operation of the device.

Customer Support

AcuRite customer support is committed to providing you with best-in-class service. **For assistance**, please have the model number of this product available and contact us in any of the following ways:



(877) 221-1252



info@chaney-inst.com

24/7 support at www.AcuRite.com

- ▶ Installation Videos
- ▶ Register your Product
- ▶ Instruction Manuals
- ▶ Support User Forum
- ▶ Replacement Parts
- ▶ Submit Feedback & Ideas

IMPORTANT

PRODUCT MUST BE REGISTERED
TO RECEIVE WARRANTY SERVICE

PRODUCT REGISTRATION

Register online
to receive 1 year
warranty protection

www.AcuRite.com

FOR NOW

SUPPORT

Support Forum

Archived Products

▶ Register a Product

Limited One Year Warranty

At AcuRite, we proudly uphold our commitment to quality technology. Chaney Instrument Co. warrants that all products it manufactures to be of good material and workmanship, and to be free of defects when properly installed and operated for a period of one year from the date of purchase.

We recommend that you visit us at www.AcuRite.com for the fastest way to register your product. However, product registration does not eliminate the need to retain your original proof of purchase in order to obtain warranty benefits.

Chaney Instrument Co. warrants that all products it manufactures to be of good material and workmanship, and to be free of defects when properly installed and operated for a period of one year from the date of purchase. Remedy for breach of this warranty is limited to repair or replacement of the defective item(s). Any product which, under normal use and service, is proven to breach the warranty contained herein within ONE YEAR from date of sale will, upon examination by Chaney, and at its sole option, be repaired or replaced by Chaney. Transportation costs and charges for returned goods shall be paid for by the purchaser. Chaney hereby disclaims all responsibility for such transportation costs and charges. This warranty will

not be breached, and Chaney will give no credit for products it manufactures which have received normal wear and tear, been damaged (including by acts of nature), tampered, abused, improperly installed, damaged in shipping, or repaired or altered by others than authorized representatives of Chaney.

The above-described warranty is expressly in lieu of all other warranties, express or implied, and all other warranties are hereby expressly disclaimed, including without limitation the implied warranty of merchantability and the implied warranty of fitness for a particular purpose. Chaney expressly disclaims all liability for special, consequential or incidental damages, whether arising in tort or by contract from any breach of this warranty. Some states do not allow the exclusion or limitation of incidental or consequential damages, so the above limitation or exclusion may not apply to you. Chaney further disclaims all liability from personal injury relating to its products to the extent permitted by law. By acceptance of any of Chaney's products, the purchaser assumes all liability for the consequences arising from their use or misuse. No person, firm or corporation is authorized to assume for Chaney any other liability in connection with the sale of its products. Furthermore, no person, firm or corporation is authorized to modify or waive the terms of this paragraph, and the preceding paragraph, unless done in writing and signed by a duly authorized agent of Chaney. This warranty gives you specific legal rights, and you may also have other rights which vary from state to state.

For in-warranty claims:
Chaney Instrument Co. | 965 Wells St. | Lake Geneva, WI 53147

ACURITE®



Weather
Stations



Temperature
& Humidity



Weather
Alert Radio



Kitchen
Thermometers
& Timers



Clocks

It's More than Accurate, it's ACURITE®.

AcuRite offers an extensive assortment of precision instruments, designed to provide you with information you can depend on to Plan your day with confidence™.

www.AcuRite.com